

*?????????

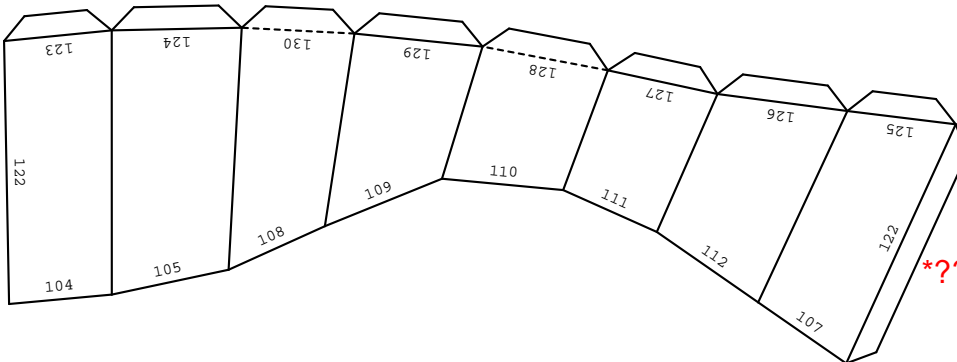

*????????:???????????????

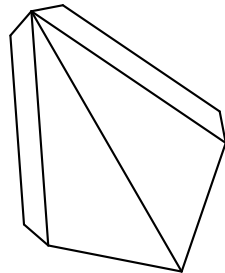
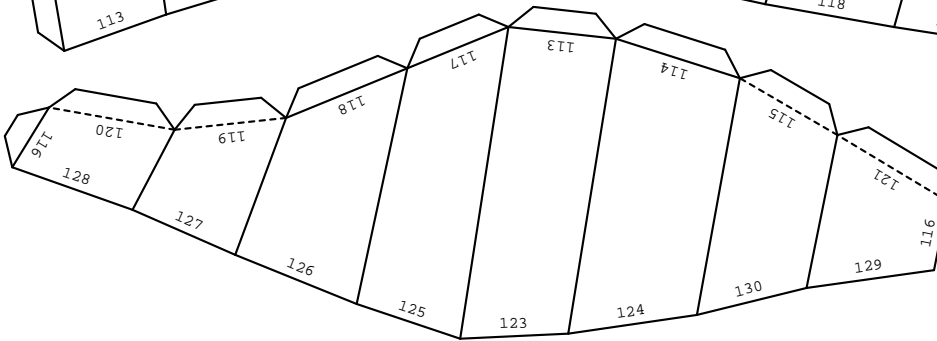
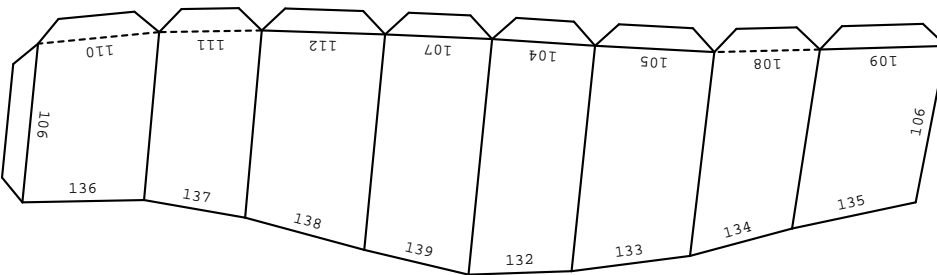
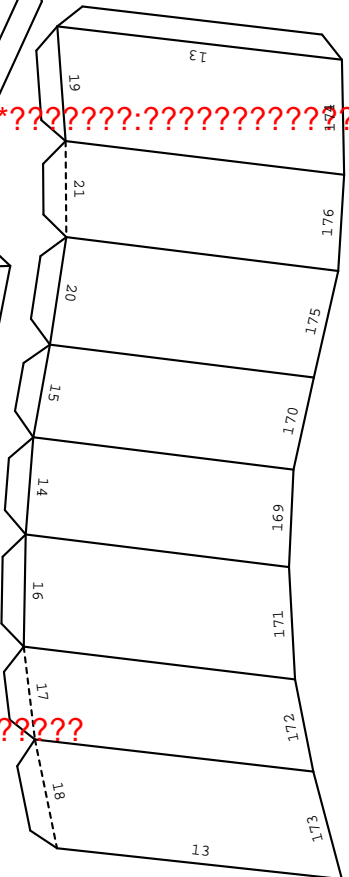

*?????

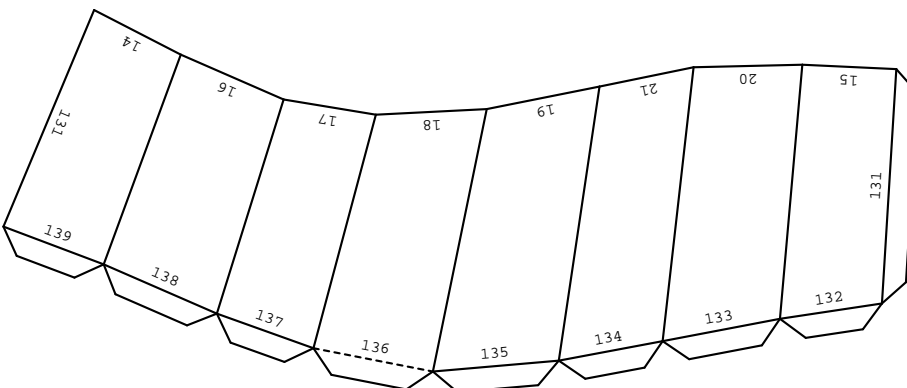

1/3 (row1 col1)

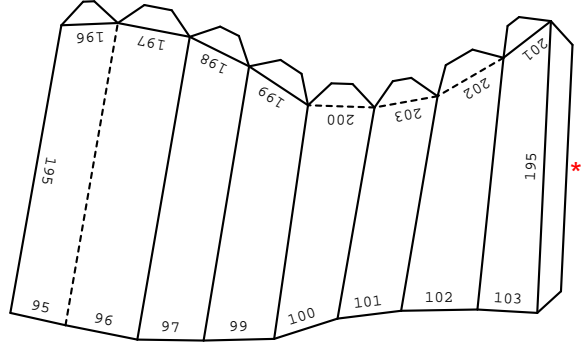
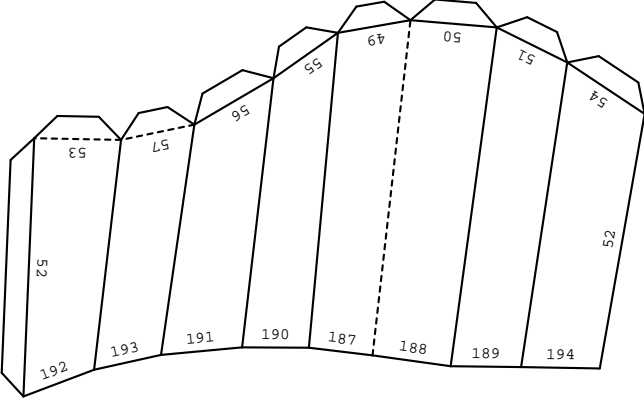
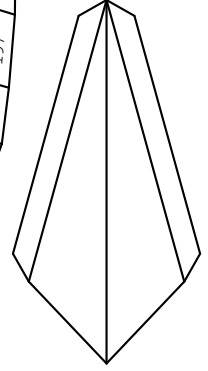
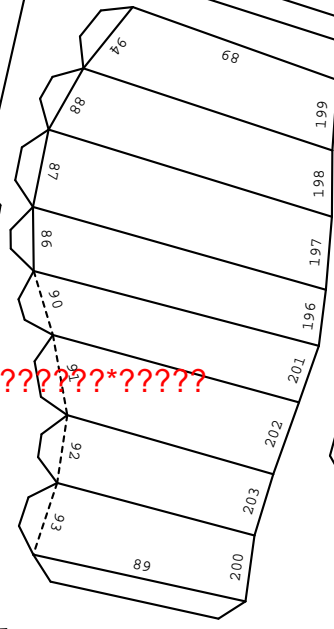
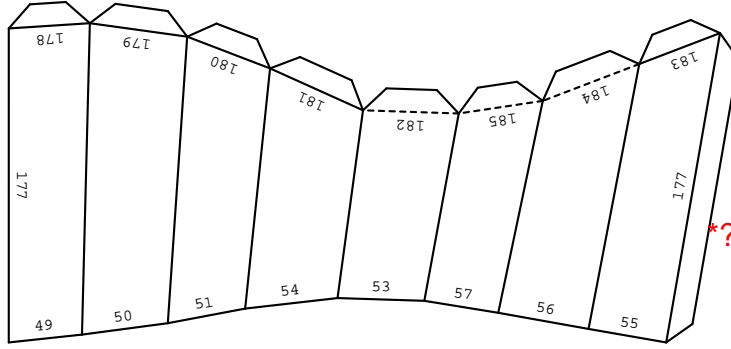
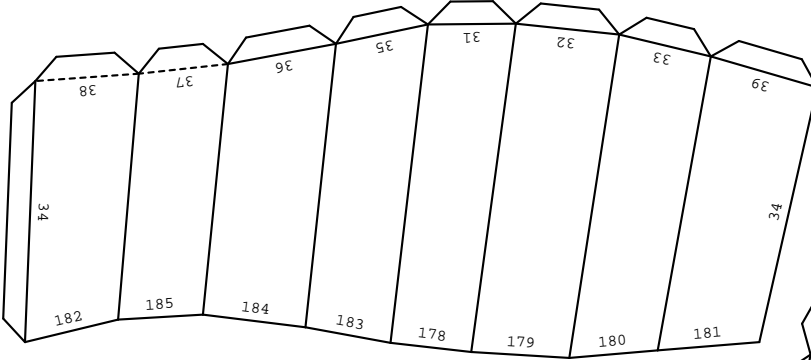
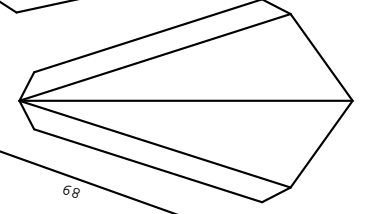
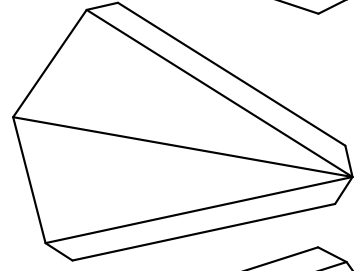
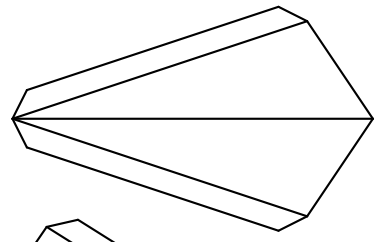
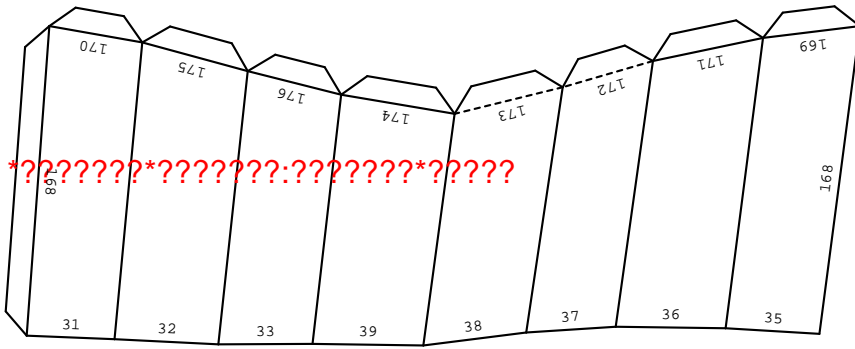

??

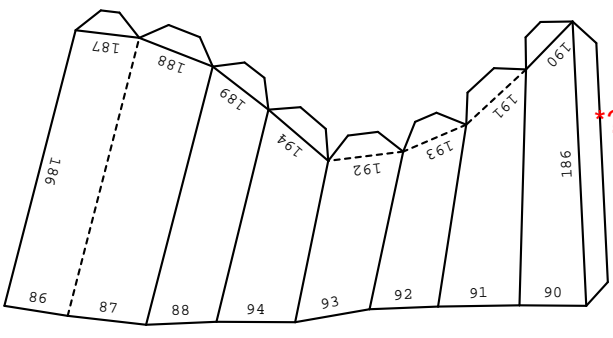

????????*????????*?????

